

TAIHO

ぷらす2

FILE No. ADULT-X



for
ADULT ONLY

スタジオ・ワラビー

KURA 蔵王 OH

PRESENT



TAIHO
FILE No. ADULT-X

5 ~ 20

X - 001

NATSUMI

23 ~ 40

X - 002

MIYUKI

42

あとがき

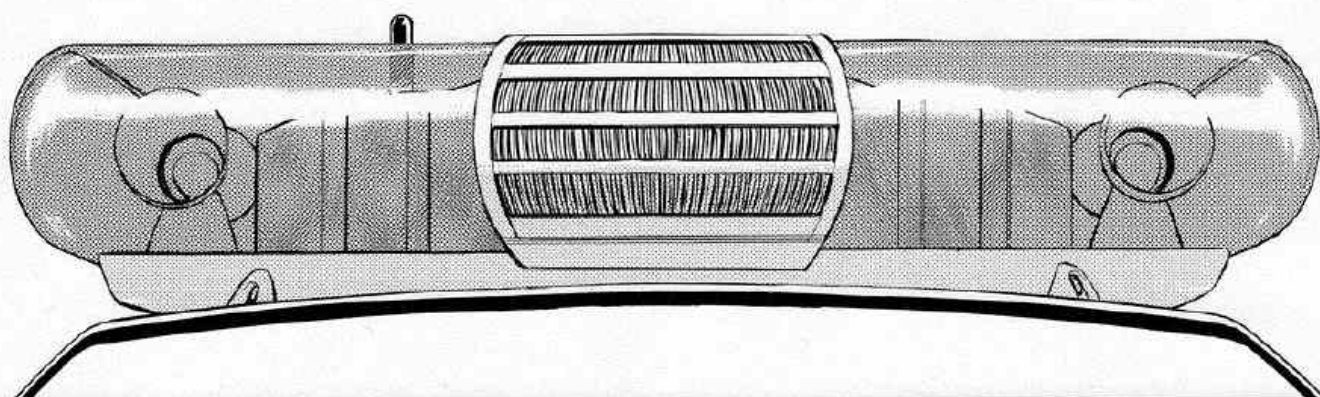

さて
終わった
終わったあ!!

さっさと帰るわよお

何よ:
何かあるの?

気持ち悪いなあ

知りたい?
知りたいあい?!

ムフフ...

なのお♡

デェ
〜
+

今日は
課長とお



女の友情なんて
女の友情なんて...

しよ...しよせん...

ぬ!!

み...ゆ...
ま...

ど...お...
ど...お...
ど...お...

はっ

こ...お...
ま...お...
ま...お...

クラ
アイ...

なんだなんだ

あ...あ...
あ...あ...
あ...あ...

今日は飲むぞおお!
おらあああ!!

またか...

ねえ...

に...あ...
あ...あ...
あ...あ...

嫌な予感が...

天川 医





だまって抱いて
なぐさめてよお



ガタガタ
うるさいぞお
なあゝかあゝ
じまあゝゝゝ

分かった!
分かったから……
むね……
むね!!



男だったら……
男だったらさあ……

こういう時は……



にあゝにゝゝ



美幸よりうまくして
あげるからさあゝゝ……

バツ
グアイ
バカ言え……

俺らまだ
こんな
事……



リップなの
ついてんじゃあん♡

しゅじゅいせいおおおお



おおっ♡

それでも
をそこやあゝゝ

わあああ





ケンちゃん
はやあ〜〜いい

クス♡
たまつてたんだあ

本当は美幸に
入れたくてたまら
ないんでしょあ



ケンちゃんも…
警官である前に
一人の男だもんねえ♡

…
…
…



美幸も
罪な女ねえ



今までずっと
一人でしてたのあ？

おっ…
おいおい
これ以上は…



いいから
いいから…

ま・か・せ・て・え♡



んん〜♡

ブクブク

つつ…辻本お！
出るっ！！

ふふっ

かあ〜わい〜
ケンちゃん

田中君♡

じゃあ

だ
射精してえ♡

あゝ
あの
なあ



あゝあゝ…はああ

びびり
びびり
びびり

なかだし
腔内射精いい…♡

あゝあゝ…



はあ
はあ









あっ…

辻本…
気持ちいいか…



っ…辻本…

はあ

はあ

はあ

はあ

ああああ

ああ

ああ

ああ

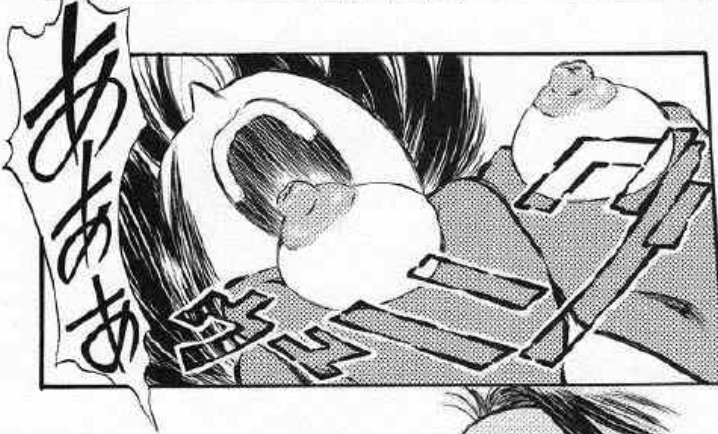

あああ

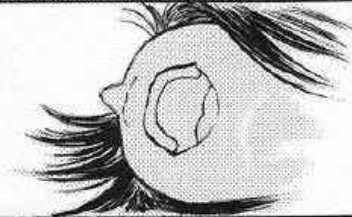

か



辻本…

お願い…もっと強く
抱きしめて…



か…ちよお…



あん…

辻本…



あ

はあ



だまって…

男ならさあ…



ああ
ああ
ああ

あ

はあ

うぐ
うぐ
うぐ

はあ

くっ

はあ



キス...

して...



お...
お願い...



あ...
あはあ
ああ

あっ!
いつ...
イキそお...



イ?
イ?
イ?
イグう!!

はあ

はあ

はあ
はあ





え？

中…
嶋君…



え…

えとおお…



ん？

はあ

はあ

はあ



つ…辻本…

？……………！！



あ…あのおう…

ハハハ…



中嶋くさん

てのしんかオ

入るわよお…

夏実がまだ
もどらないから…

もしかしてと…思っ…

火の用心



夏・実…？







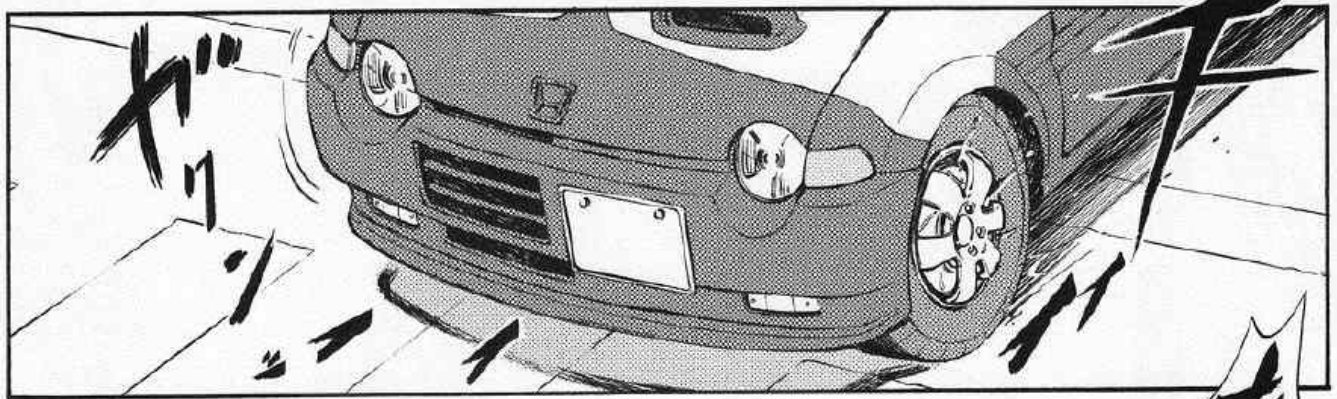
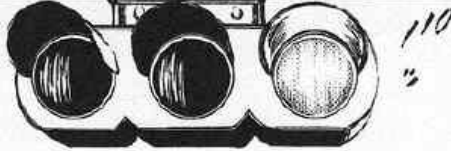





あんたが
悪いのよ
美幸

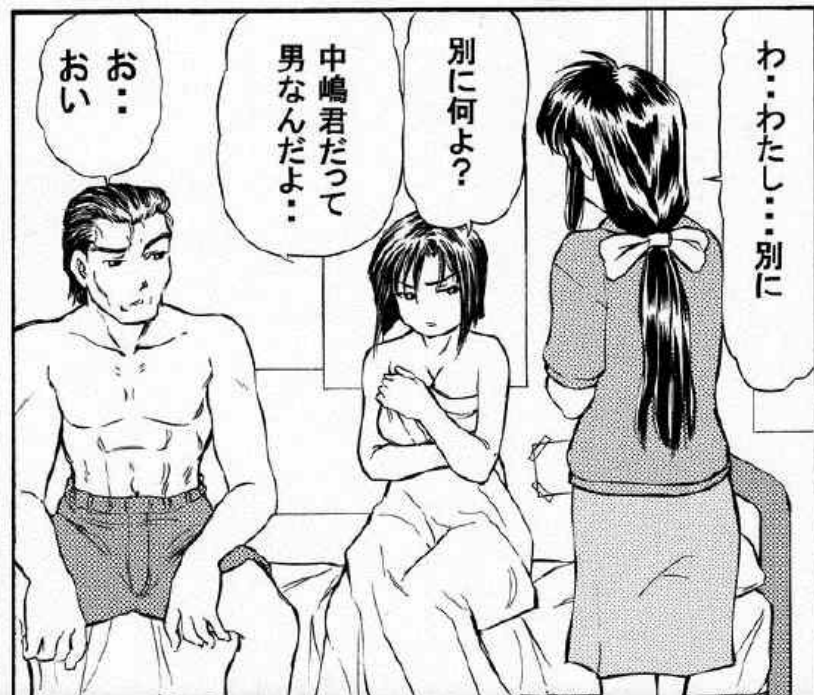



あたしが悪いのに

あたしってば何言ってるんだろ



小早川...



「めん...



辻本...



ホント...

「めんね...



パトロール
行って来ます

お...おう...



課長!



あゝ頼子君
そろそろ仕事に
戻ってくれんかね

ほらほら...
頼子さん

あはははあ
あはははあ

...

あたしの性格
知ってるでしょ

言いたい事あるなら
言ってみよ

わたし…別に…

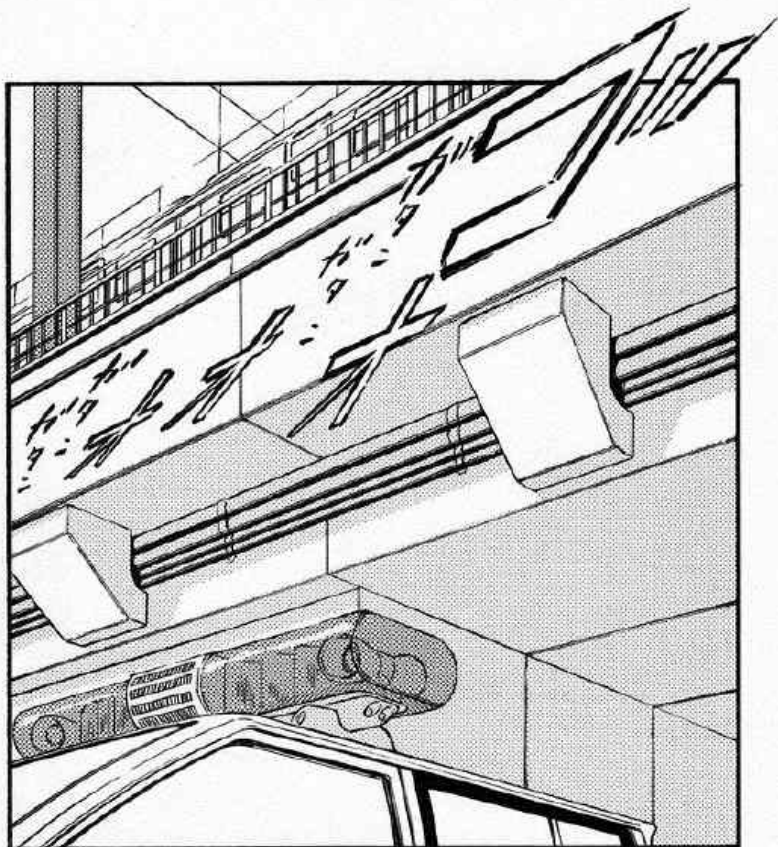

はっ…
話がある!

な…中嶋くん…

小早川—!!



あたし
その辺パトロール
して来るわ

夏実

辻本…



そ…その

……





なっ!?



やらせてくれ!!

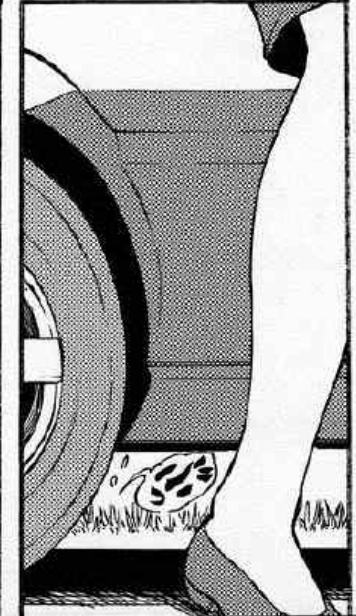

小早川!

直球というか
不器用っちゅうか
...らしいわあ...



わたしも…その…

……ごめん…なさい



俺が悪いんだ…

俺もハッキリ
しなかったから



こんな所で…?

あゝ



でも…

え…



だ…

大丈夫中嶋くん

動きにくいな…

くそお…

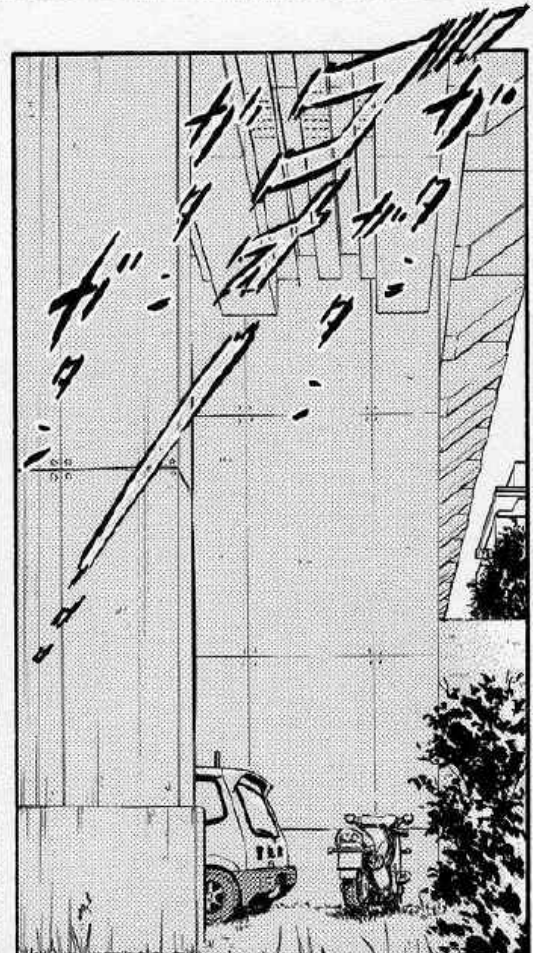



やっぱり...その...

帰ってから...
落ちついてゆっくり...

きゅ...

ス
ッ



今やる!

はい
はい

は...



おっぱいおっぱい

ス
ッ

...



だったら...



おっぱいおっぱい

は...はいはい...

男にとって
好きな女の
裸が見れるってのはなあ...

こっちが
はずかしい
でしょ...



おっぱいおっぱい

な...なっ...
泣く程の事...??



小早川……

……



その気持ち……
ずうっと持ち続けてね……



美幸ってば

ああ
無茶なんだ
おはあ



小早川あ！

あああ



課長お……

あ……

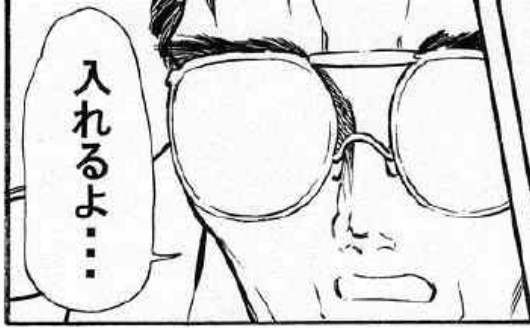

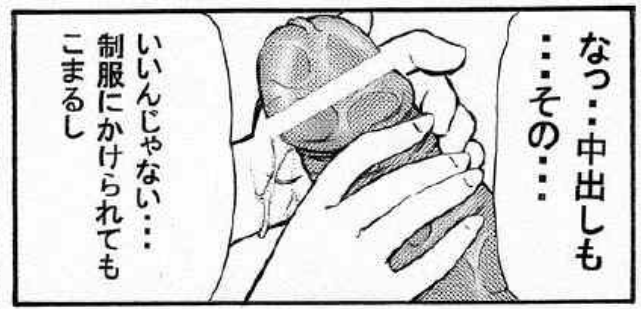





中嶋くん
激しすぎ!!

やつ..やだ!!

おおっ!!
こっちが動きやすい!!



あぁ..あぁはぁ..
あぁはぁ..



なんか俺
この間から
リードされっ
ぱなしな気が
...

っつ...



んっ



小早川...

なっ..なんで分かった...



ダメよ♡

今よけいな事
考えたでしょ



小早川!!

な・中嶋くん・

中嶋くん・

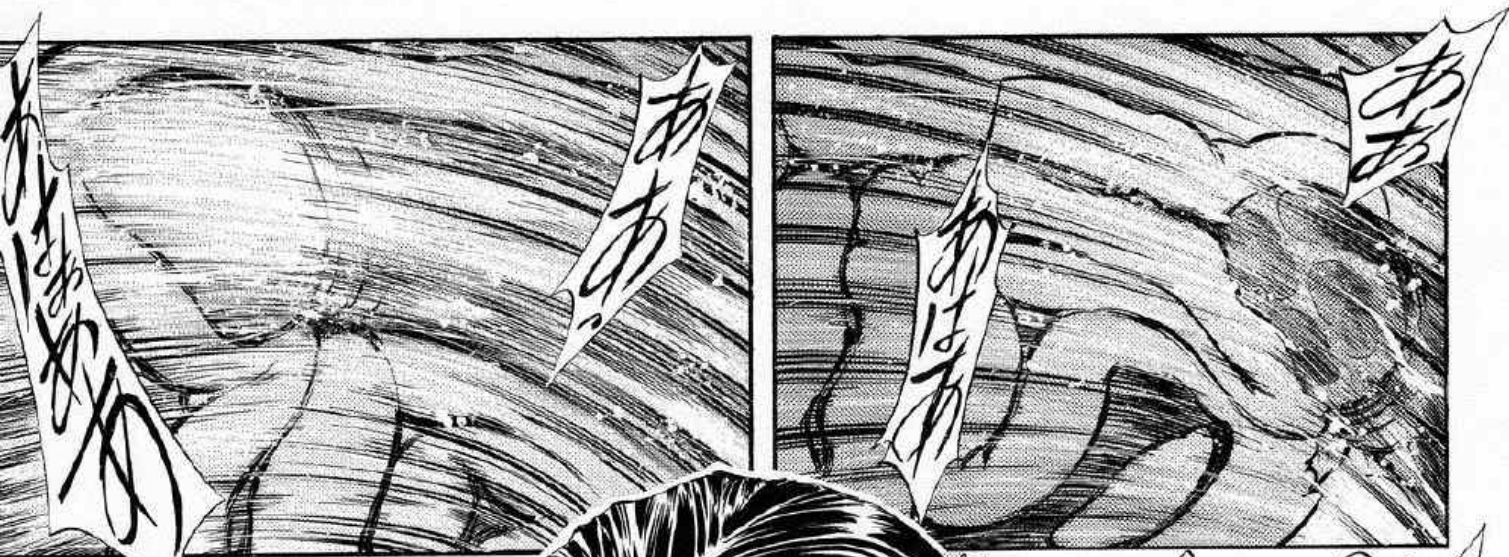

あああ・中嶋くん

わたし・

わたし

ああ

ああ

ああ

ああ

ああ





えっ……い……いえ……

昨日は
すまなかつたなあ



はっ……はっ……
はい……!!

っ……辻本?

キナッ



えっ……?

今夜飲み
行くか?



はっ……

はい!
課長!!



続きは帰ってから
ゆっくりしなあ♡

中嶋あ——!

辻本……



その二人も
来るかあ
俺のオゴリだあ

いろいろと
つもる話も
あるみたい
だしなあ



キナッ——中嶋くん!!

いつまで
やっとなの!!

ま……まさか
無線……



課長お
今日スッポかしたら
浮気すつからねえ♡

もう…人の話し
聞いている…?



ささと出せ
美幸い—

あなはずつと
見ていたの!!



分かった
分かったあ

……浮気
……か…

よっしああ!

今日こそっ!

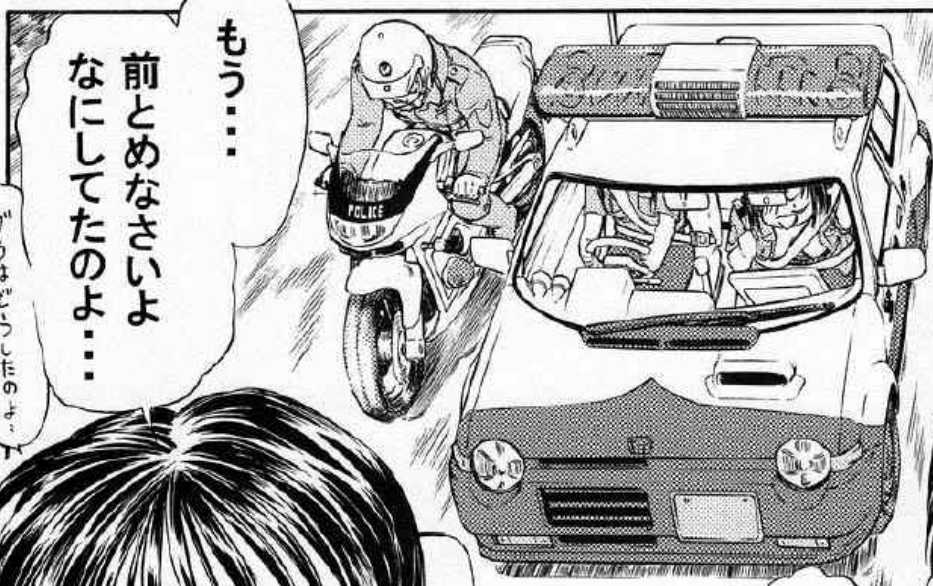

もう…
前とめなさいよ
なにしてたのよ…

しんがはなましつてのや…



なんだ
なんだ…

何がどう
なってる…



おとがき

お初のおなさま、初めまして。お久のおなさま、お久しぶりです。蔵王(くらおう)です。

2年ぶりのワラビでの個人誌となりました。

商業の合間に描いていたら、スケジュールはもあて遅れに遅れてしまいました。

もしなんとかしろよ、ワシ、…うう。

蔵王月

<http://www3.cnet-ta.ne.jp/o/ohkura>

《2004.02.29 現在》



誌 名 / TAIHO
発行元 / スタジオ・ワラビー
編集：企画 / 「TOY TOWN・J」
絵 師 / 蔵 王
発 責 / 赤城 隼人
発行日 / 2004年04月29日
印刷・製本 / PICO
連絡先 / <http://www.toy-town.org/>

<<注意事項>>

0112

- 発行元の許可なく本誌の一部、又は全部の無断複製・複写・転載・翻訳を禁止します。
- 本誌は国内向けです。海外へは持ち出さないでください。
- 本誌は成年向けです。18歳未満の方の本誌購読、譲渡はご遠慮下さい。
- また、18歳以上でも影響を受けやすい性格の方の閲覧もご遠慮下さい。
- 洒落、ジョーク&ユーモアのわからない方の購読もご遠慮ねがいます。
- 通信販売とかもやっていますのでバックナンバーっていうか不良在庫っていうか、たくさんありますんで興味をもたれた方や買ってあげようかな、なあーんとすこしでもおもってくださった方は是非、上記の連絡先へアクセス!

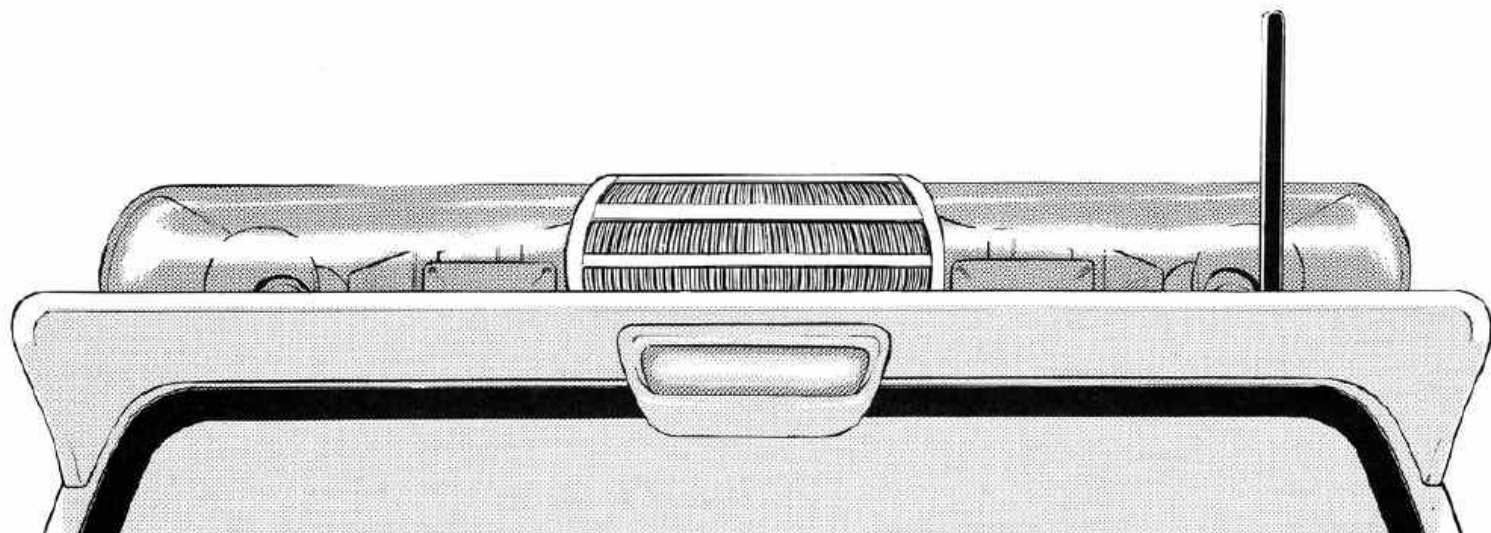



for
ADULT ONLY